

*Atys 200x100*

PREDINSTALACIJA  
PREDINSTALLATION  
PREINSTALLATION  
VORINSTALLATION

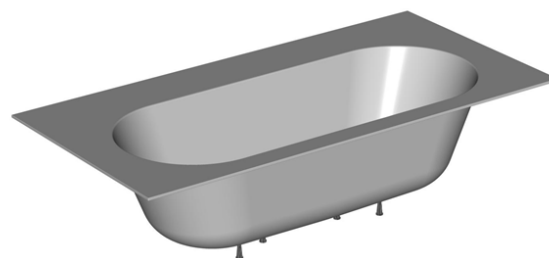
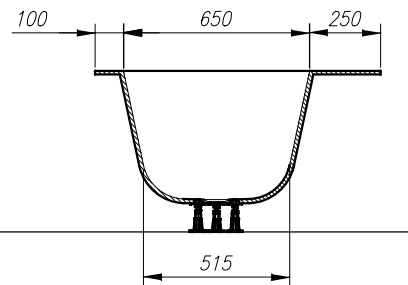
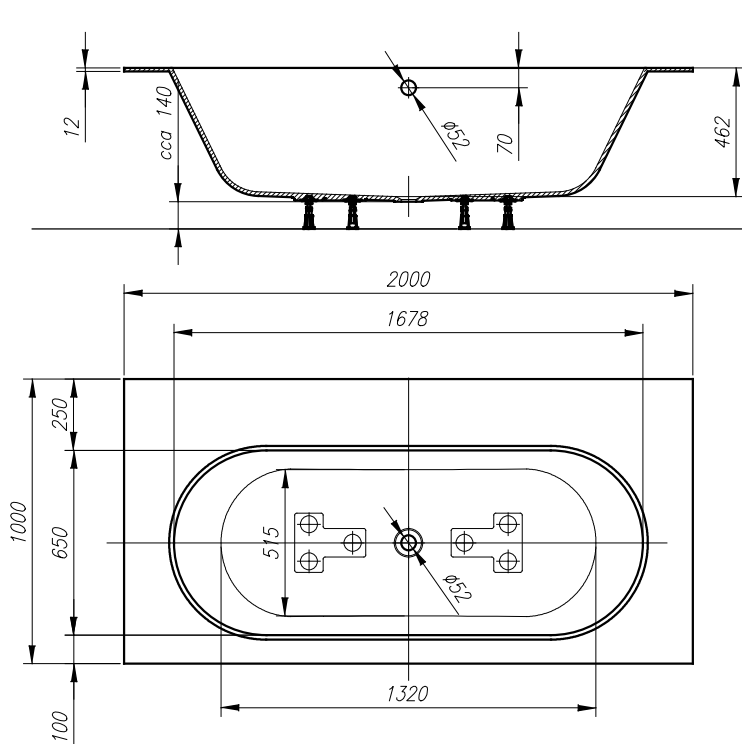

225 L

**VOLUMEN**  
**VOLUMEN**  
**VOLUME**  
**VOLUMEN**

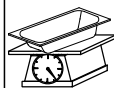

86 kg

**TEŽA**  
**TEŽINA**  
**WEIGHT**  
**GEWICHT**

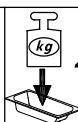

410 kg

**MAX. OBREMENITEV**  
**MAX. OBTEREČENJE**  
**MAX. LOAD**  
**MAX. BELASTUNG**

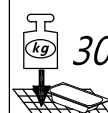

300 kg/m<sup>2</sup>

**OBREMENITEV TAL**  
**OBTEREČENJE PODA**  
**FLOOR LOAD**  
**BODENBELASTUNG**

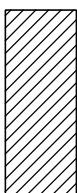

- Priklop tople in hladne vode 1/2", min 0,2 Mpa, max 0,4 Mpa
- Priključak tople i hladne vode 1/2", min 0,2 Mpa, max 0,4 Mpa
- Connection of hot and cold water 1/2", min 0,2Mpa, max 0,4Mpa
- Anschluss Warm- und Kaltwasser 1/2", min 0,2 Mpa, max 0,4 Mpa
- Prostor za odtok Ø 50 mm
- Mjesto za odtok Ø 50 mm
- Drain spot Ø 50mm
- Abflussplatz Ø 50 mm

*priporočilo za vgradnjo*  
*preporuka za ugradnjo*  
*installation recommendation*  
*Einbauempfehlung*

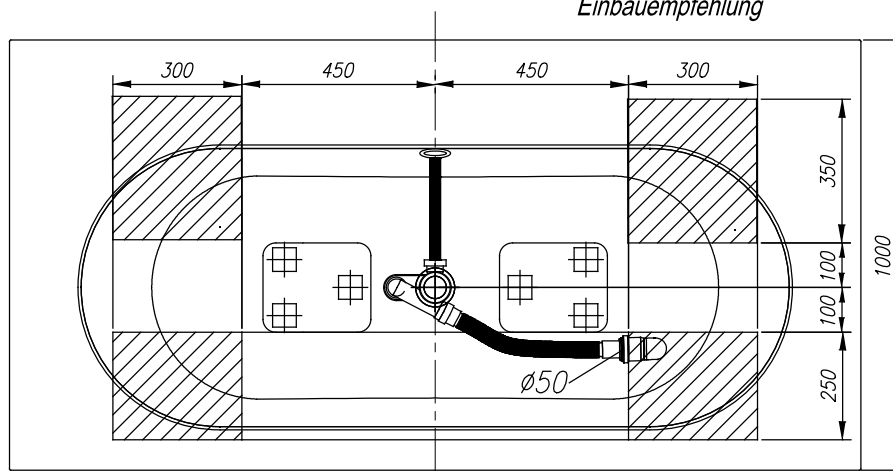

kopalna kad brez oblog - navodilo za vgradnjo  
Kada bez obloge - upute za ugradnjo  
Bathtub without panel - installation instructions  
Badewanne ohne Schürze - Einbauanleitung

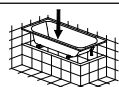

Nr. MKKE 29

Kopalna kad iz KERROCK-a  
Kada za kupanje iz KERROCK-a  
Bathtub from KERROCK  
Badewanne aus KERROCK



- MEŠALNI VENTIL TOPLA/HLADNA  
 - VENTIL ZA MIEŠANJE TOPLO/HLADNO  
 - MIXING VALVE HOT/COLD  
 - MISCHVENTIL WARM/KALT

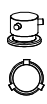

- PREKLOPNIK ROČNA PRHA/IZLIV  
 - PREKIDAČ ZA RUČNI TUŠ/IZLJEV  
 - HAND SHOWER/SPOUT SELECTOR SWITCH  
 - SCHALTER FÜR HANDBRAUSE/AUSLAUF

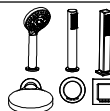

- ROČNA PRHA  
 - RUČNI TUŠ  
 - HAND SHOWER  
 - HANDBRAUSE



- IZLIV  
 - IZLJEVNIK  
 - SPOUT  
 - AUSLAUF

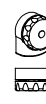

- IZLIV NA PRELIVNI GARNITURI  
 - IZLIEV NA PRELIEVNOM SETU  
 - SPOUT ON THE OVERFLOW SET  
 - AUSLAUF AN DER ÜBERLAUFGARNITUR

- OPCIJA ENOROČNA ARMATURA WATERFALL
- OPCIJA JEDNORUČNA ARMATURA WATERFALL
- OPTION ONE HAND FITTING WATERFALL
- MÖGLICHKEIT EINWEG-ARMATUR WATERFALL

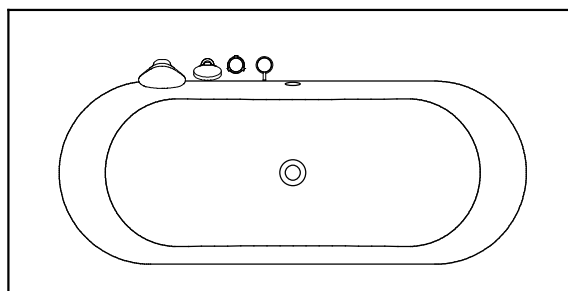
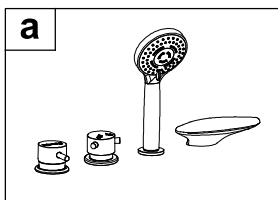

- OPCIJA ENOROČNA ARMATURA RAINDROP
- OPCIJA JEDNORUČNA ARMATURA RAINDROP
- OPTION ONE HAND FITTING RAINDROP
- MÖGLICHKEIT EINWEG-ARMATUR RAINDROP

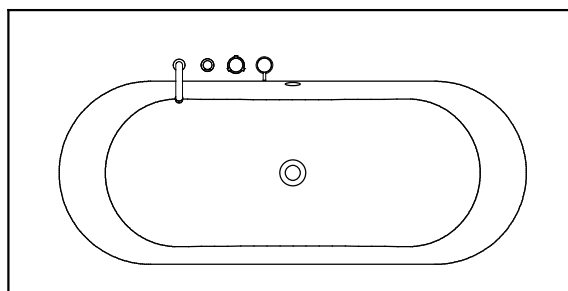
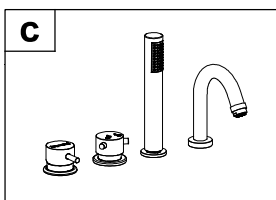

- OPCIJA ENOROČNA ARMATURA STREAM ( CHR / BLACK )
- OPCIJA JEDNORUČNA ARMATURA STREAM ( CHR / BLACK )
- OPTION ONE HAND FITTING STREAM ( CHR / BLACK )
- MÖGLICHKEIT EINWEG-ARMATUR STREAM ( CHR / BLACK )

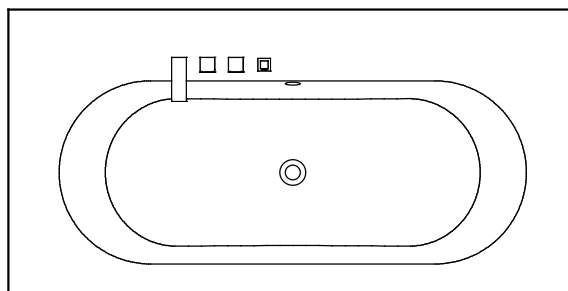
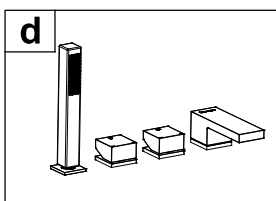

- Priklop tople in hladne vode 1/2", min 0,2 Mpa, max 0,4 Mpa  
 - Priključak tople i hladne vode 1/2", min 0,2 Mpa, max 0,4 Mpa  
 - Connection of hot and cold water 1/2", min 0.2Mpa, max 0.4Mpa  
 - Anschluss Warm- und Kaltwasser 1/2", min 0,2 Mpa, max 0,4 Mpa

priporočilo za vgradnjo  
 preporuka za ugradnju  
 installation recommendation  
 Einbauempfehlung

